

The image shows a close-up of a wooden deck floor installed over a metal joist system. The joists are dark grey and run parallel to each other. The wooden planks are light-colored and laid across the joists. In the background, there is a window with a grey frame and a stone wall on the left. The overall scene is outdoors, likely on a balcony or deck.

millboard

Live. Life. Outside.

Installation Guide for DuoSpan™ Joists & Beams

Considerations

Considerations should be made prior to starting installation on the design of the deck:

Does it include edging, a board or Bullnose Board around the perimeter?

Does the design include area to be split up in different sections?

Are the boards being laid at 90 degrees or 45 degrees?

Are the boards being laid with a herringbone or a mitre?

Does the deck have a curve?

Does it need to have access hatches for drainage outlets etc?

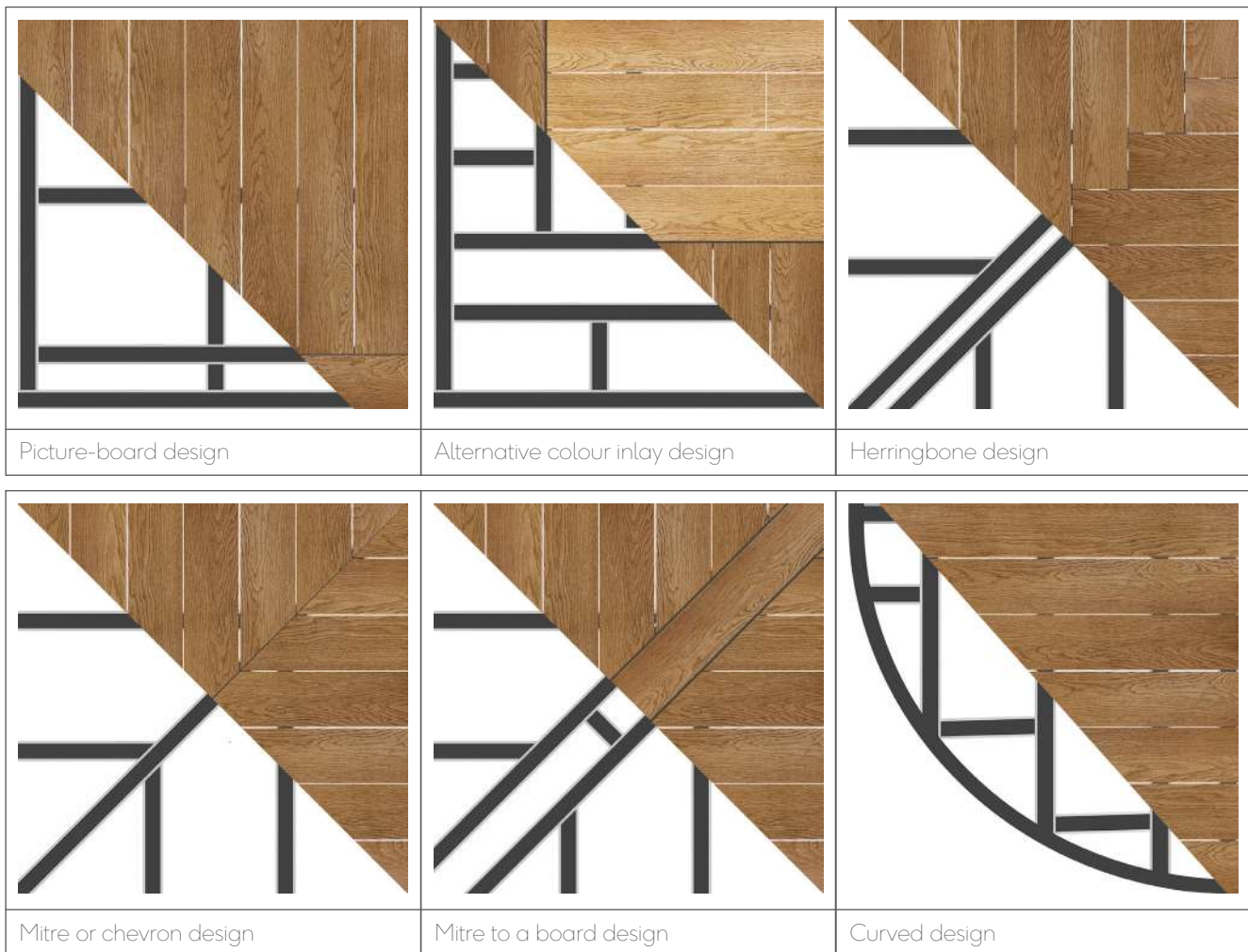

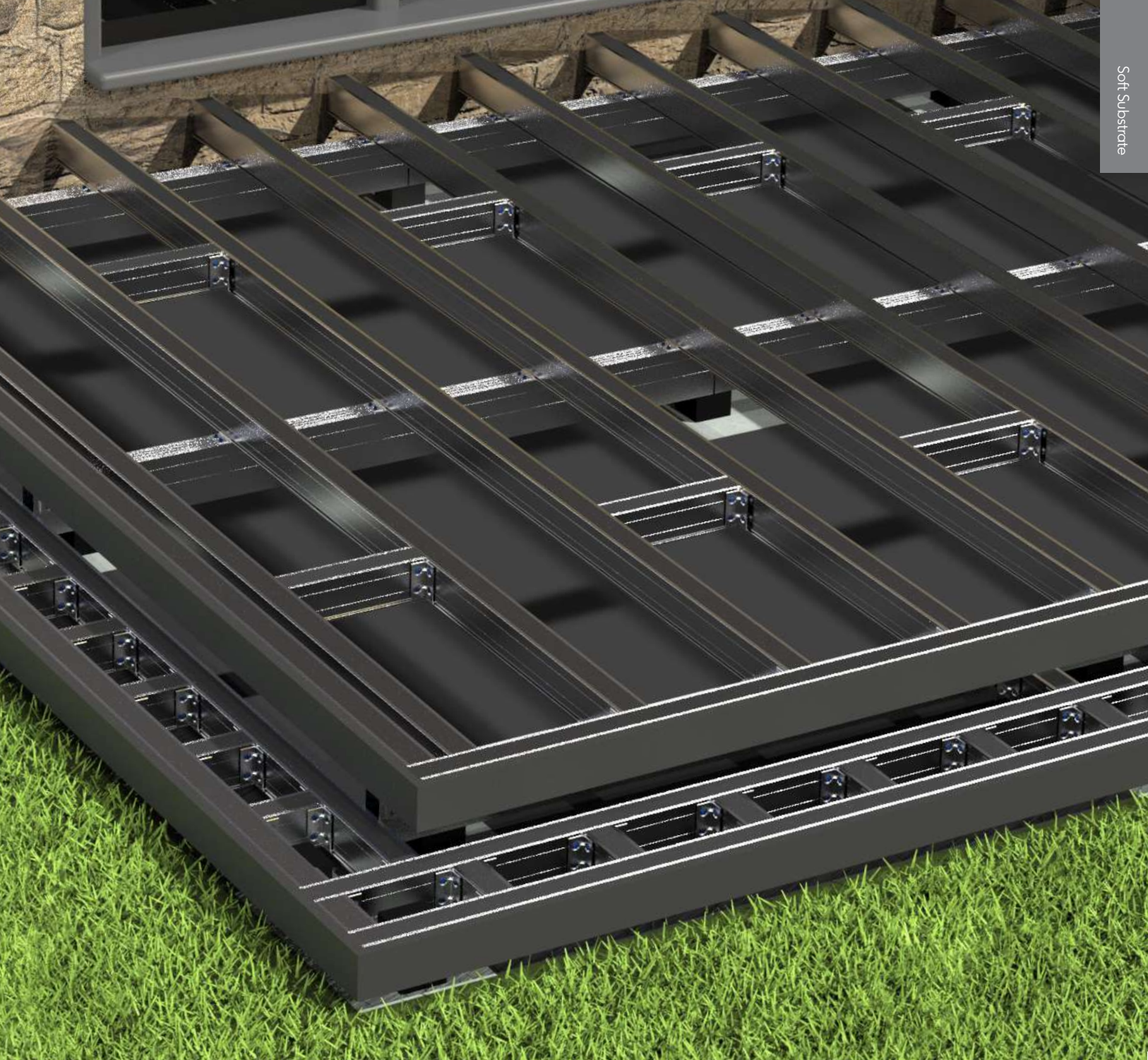

DuoSpan™ Joists & Beams Installed at ground level (soft substrate)

Simple guide for installing DuoSpan 99mm Joists & 136mm Beams with Plas-Pro Posts, to be read in conjunction with the Millboard Installation Guide when using Millboard decking boards.

1



- Excavation of the ground to get to the required height to be carried out first.
- Lay a weed membrane over the area.
- Ground pins will be needed to hold the membrane down.

2

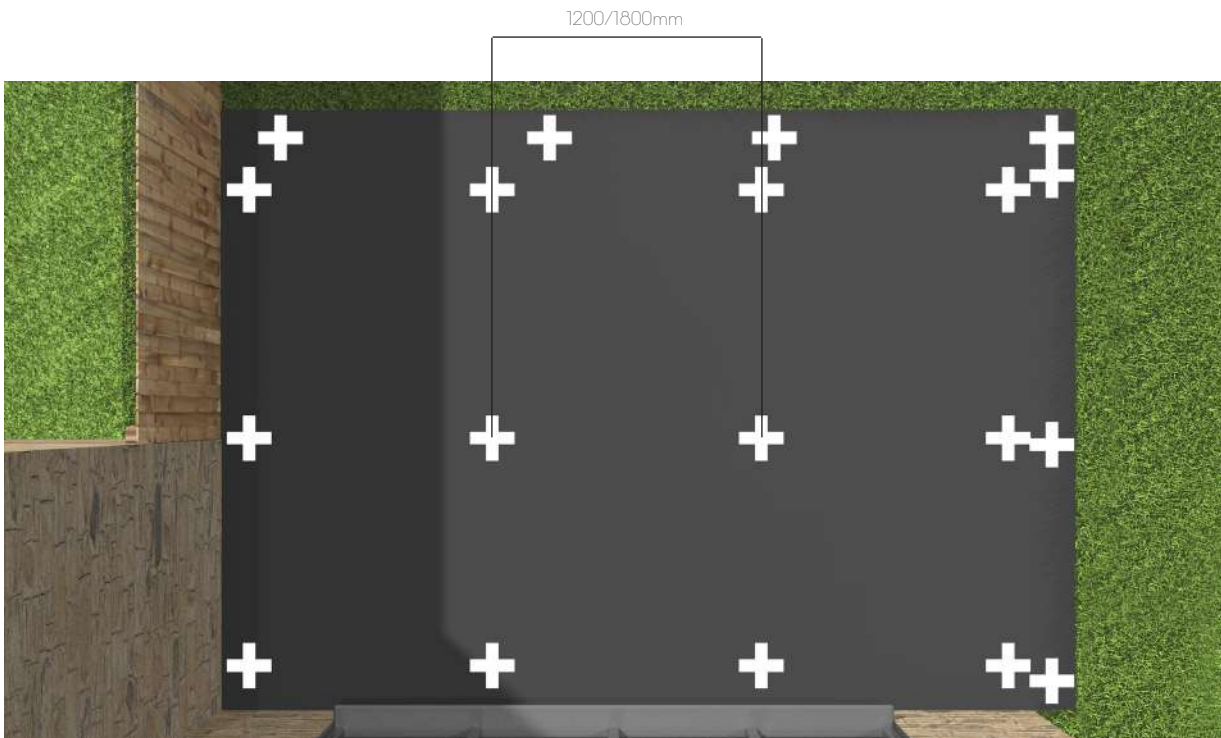

- When the weed membrane is down, mark out your decking area and where the Plas-Pro Posts should be placed.
- If any steps are to be installed, these will need to be factored in at this point.
- Make sure you consider the board dimensions when doing so as this will make the installation easier further down the line.
- If the installation is for a domestic application, then we advise having a maximum of 1800mm gap between the Post centres.
- The maximum recommended span for commercial applications is 1350mm, however as the DuoSpan Joists and Beams are 3600mm long it is more efficient to set the Posts at 1200mm centres.
- Whilst these are our recommended spans full loading tables can be found on - www.millboard.co.uk/duospan

3



- Cut the weed membrane on the marked area.
- Proceed to dig the holes to house the Plas-Pro Posts, which will support the deck.

4

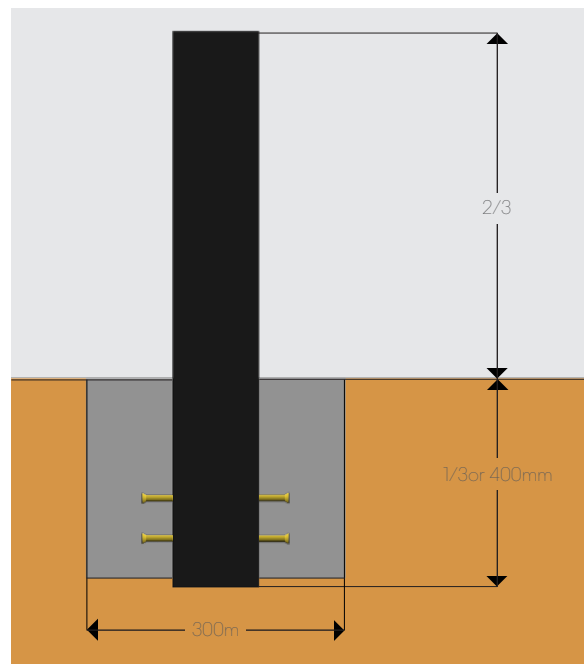

- The Plas-Pro Posts should be two thirds above ground and one third, or a depth of 400mm, in the ground, whichever is greatest.
- We recommend the hole is three times the width of the Post, i.e. 300mm x 300mm for a 100mm Post.
- It is best to oversize the post length slightly then cut once it has been secured in place.
- Plas-Pro Posts can be cut using a normal mitre saw, preferably with a TCT blade that has fewer teeth.
- When cutting it is advised to wear safety glasses, gloves and ear defenders.

5

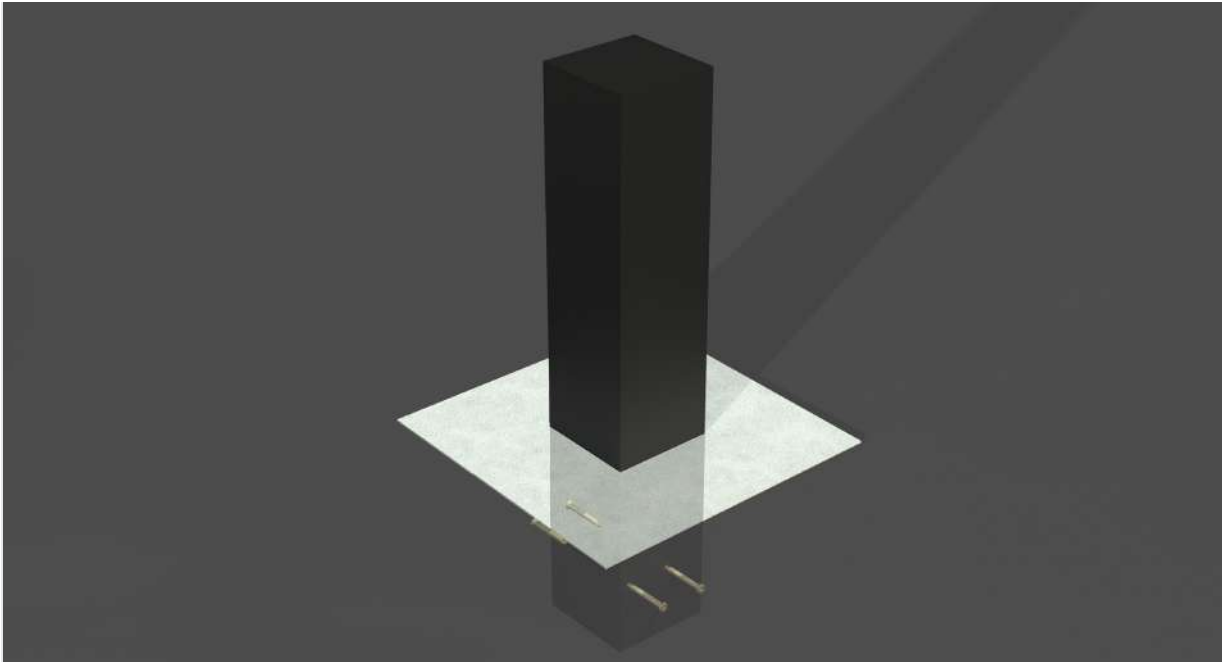

- At this point you could choose to add postcrete to secure the Plas-Pro Posts in place, they may need supporting in position whilst this sets.
- Alternatively, you could support the Posts in place to allow continual work on the deck frame and apply the postcrete at a later stage, this would be typical of an elevated deck over 600mm in height.
- To prevent the Plas-Pro Post from lifting out of the concrete, screws can be put in to the four sides of the base of the Post to create a hold in the concrete.

6

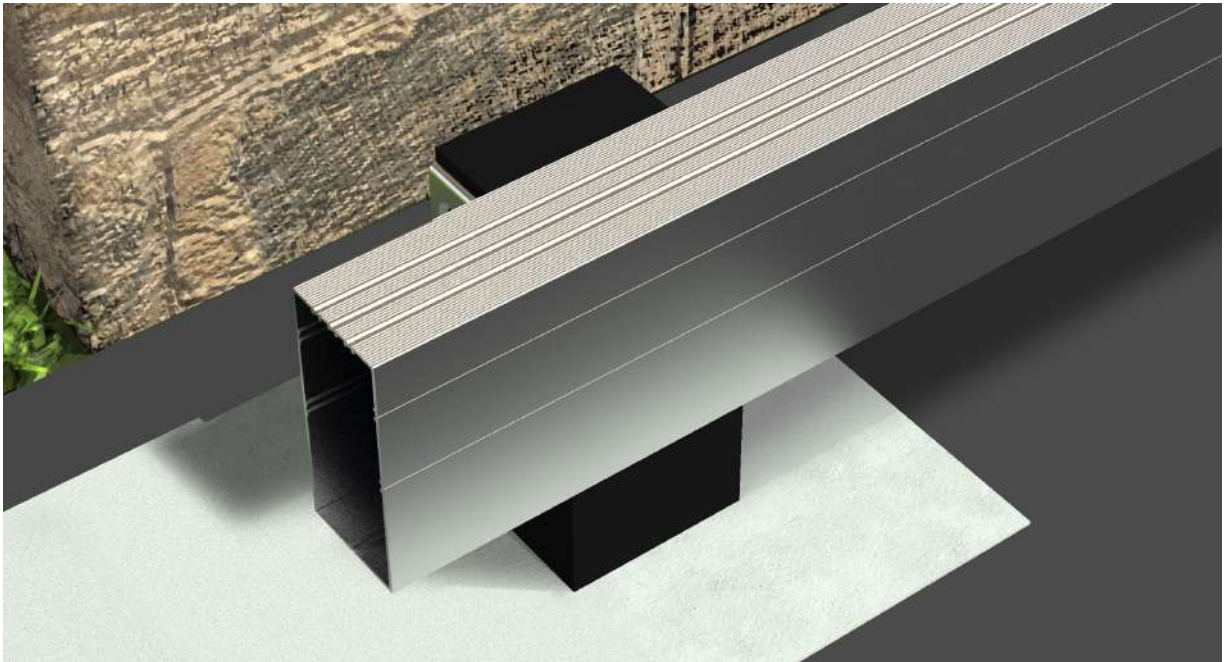

- The first DuoSpan Beam to be installed is the one nearest the house, we recommend this first Beam is set 200mm from the house supported by Plas-Pro Posts into the ground.
- The Beams need to be set so the three grooves are at the top, this will aid installation later.
- The DuoSpan Beams & Joists can be cut using a mitre saw with an aluminium cutting blade.
- Alternatively they can be cut in situ with a disc cutter with an aluminium cutting disk, do not use the same disk that has been used to cut steel as this could shatter the disk.
- When cutting the DuoSpan Joists & Beams we recommend that FFP3 dust masks, gloves, goggles, and noise-reducing ear pieces are worn.

7

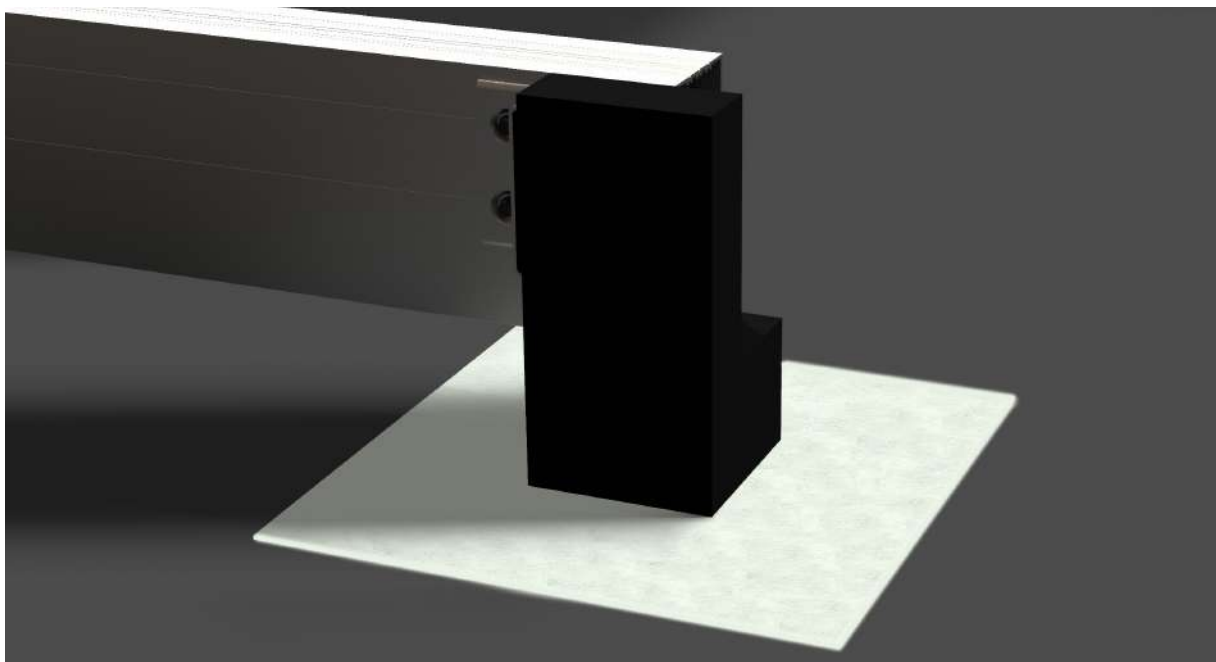

- Continue to fix the DuoSpan Beams to the Plas-Pro Posts, parallel to the first Beam at the correct centres.
- It is best practice to take a 130x60mm notch out of the top of the Posts to sit the Beam in, then use the DuoSpan 99 Flexible Bracket to either side of the Post, fixing to the Post using the DuoSpan Pan-head Screws provided. A reciprocating saw can be used to cut the notch to the top of the Post.

8

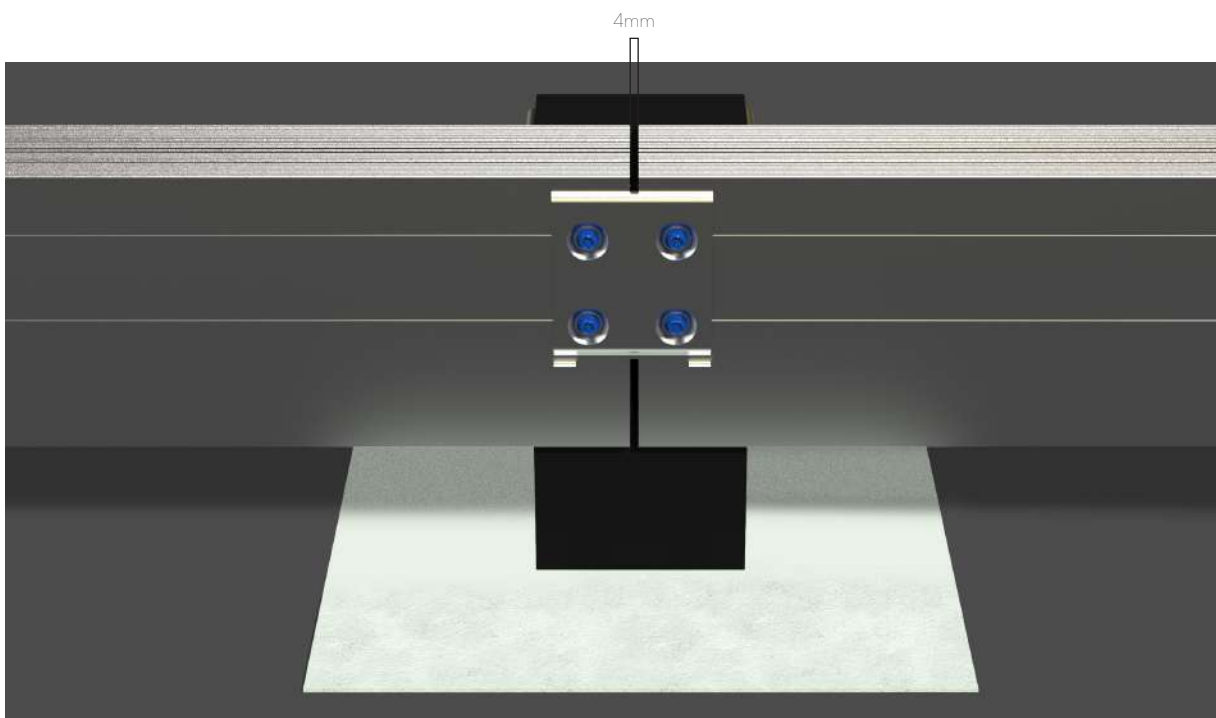

- Where two DuoSpan Beams meet on a Plas-Pro Post, a 4mm gap needs to be left to allow for potential movement.
- A DuoSpan 99 Straight Connector can be fixed to the side of both Beams to hold at the same level.

9

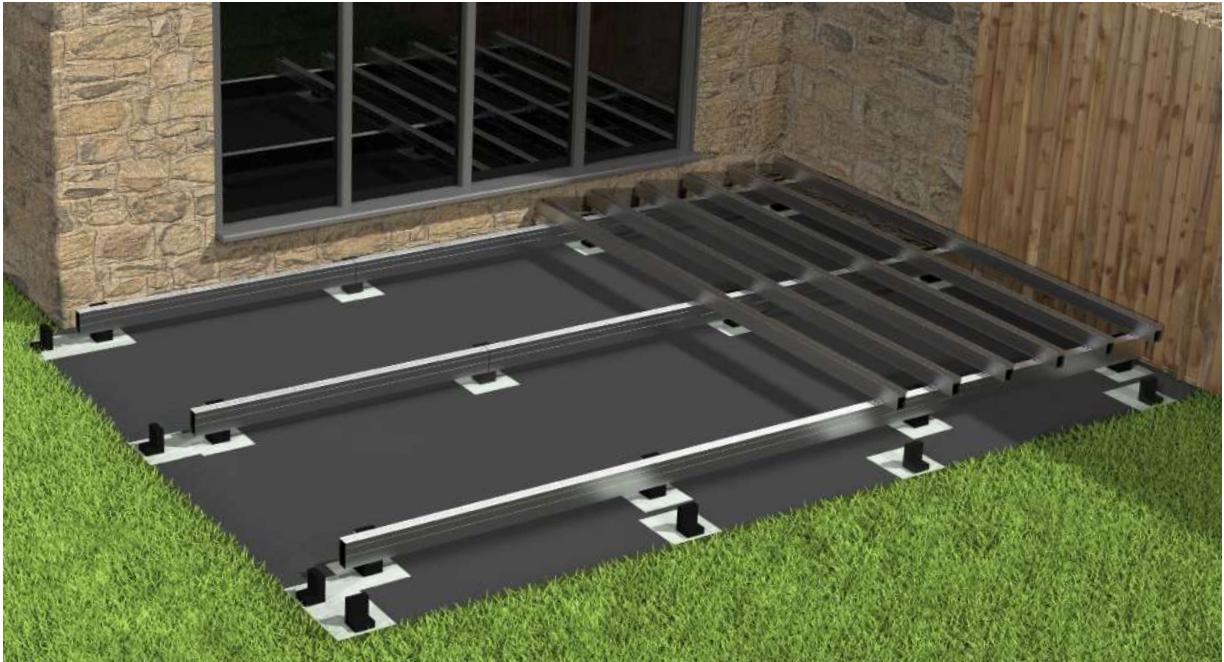

- Now the DuoSpan Beams are in place DuoSpan 99mm Joists can be installed across the top.
- The Joists are installed with a DuoSpan Hold-down Clip on either side.

300/400mm

10

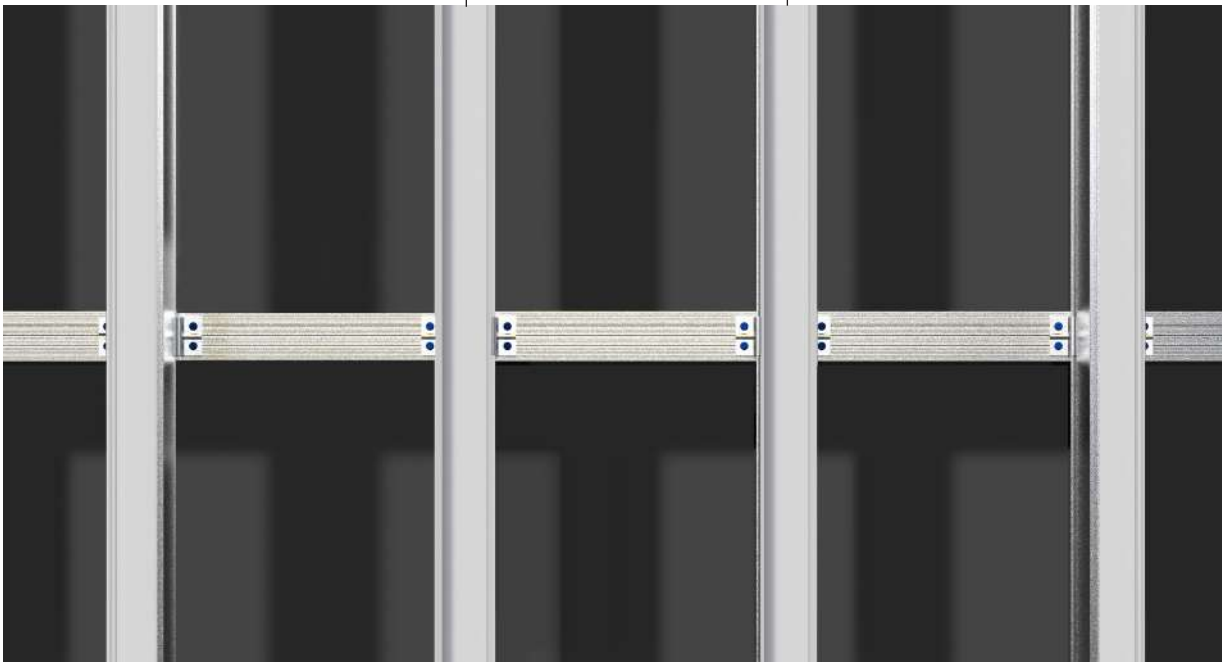

- For a residential application we recommend the DuoSpan 99mm Joists are set at 400mm centres.
- For a commercial application we recommend the joist centres are reduced to 300mm.
- This is based on the boards being set at 90 degrees to the Joists, if they are at 45 degrees to the Joists the joist centres need to be reduced to 300mm and 240mm respectively.
- Please note these are the recommendations if Millboard decking is being used, if an alternative decking product is being used the joists spacing may be different according to their specifications.

11



- Consideration should be taken at this point on whether the deck will have a board around the outside as a picture frame or a Bullnose Board, as the back of this board will need to be supported.

12



- DuoSpan Joists around the edge without a DuoSpan Hold-down Clip on both sides will need DuoSpan 51 90° Angle Brackets to the underside, attached to the DuoSpan Beam or additional noggins between the last and second to last joist to prevent any twisting.

13

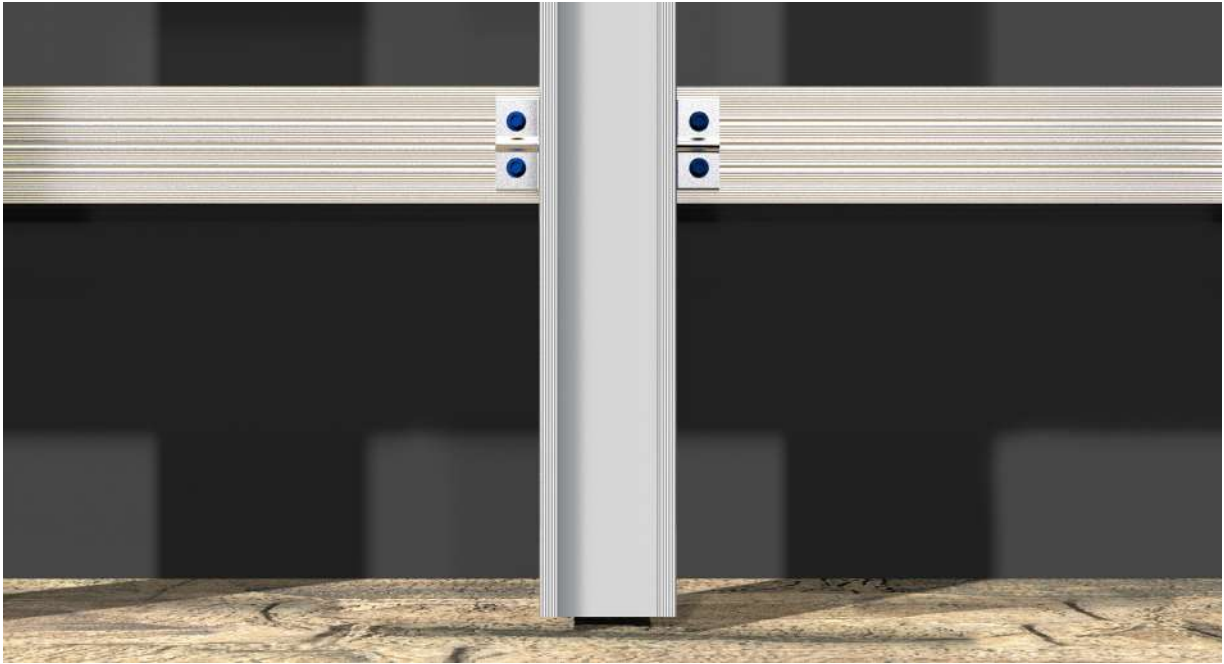

- The Joists need to be spaced 10mm from any fixed item (walls, door sills).

14

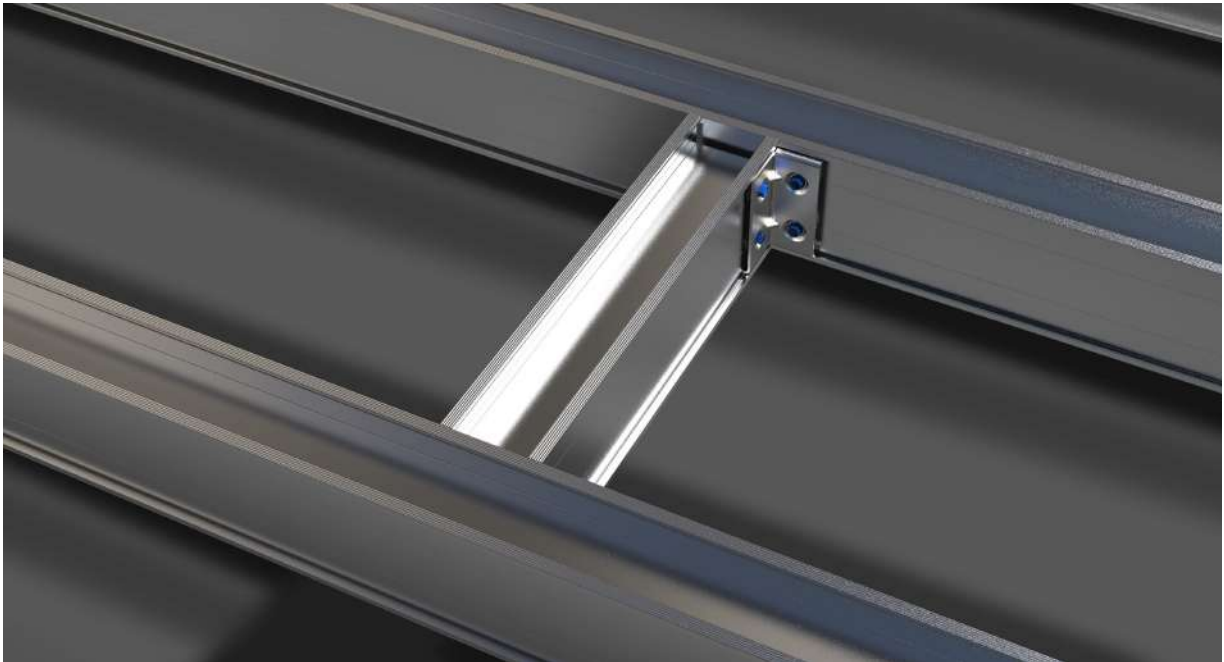

- Noggins are recommend for joist running lengths over 3.6m not attached to an outer frame, used in areas where there may be the potential risk of imposed loads causing buckling or twisting of the Joists or Beams.
- The noggins are installed with DuoSpan 99 90° Angle Brackets either side of the noggin.

15

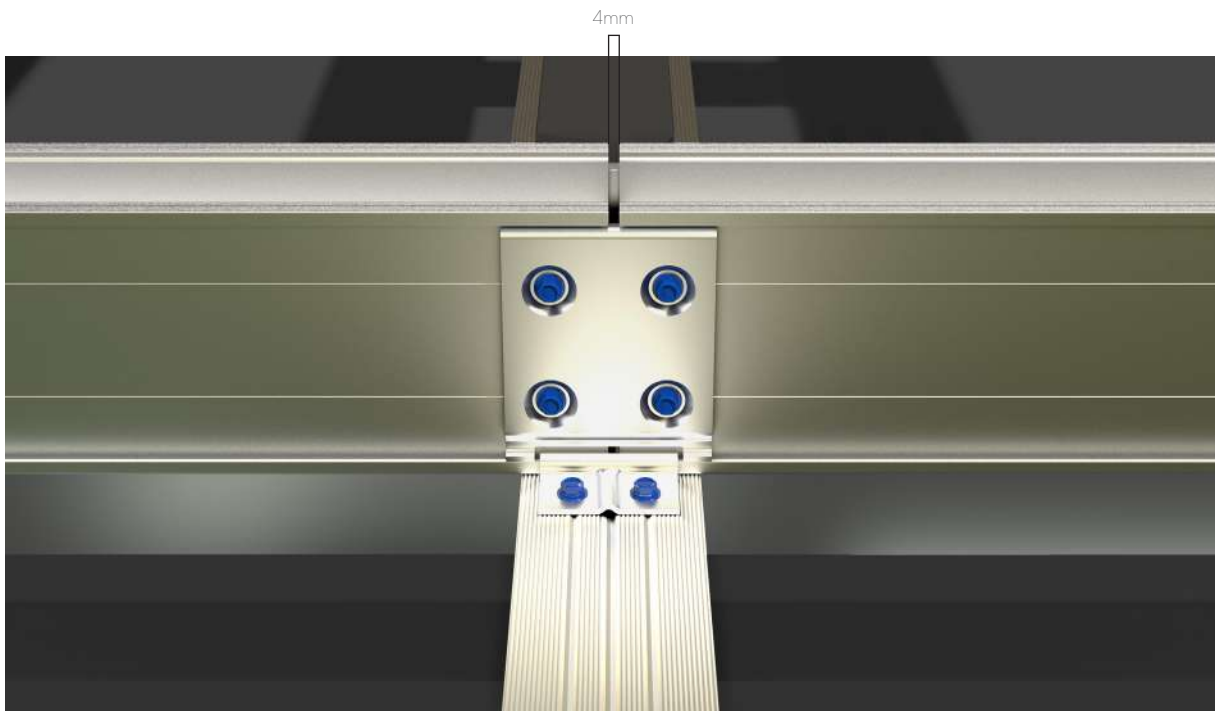

- When joining two lengths of DuoSpan 99mm Joists a DuoSpan 99 Straight Connector should be used with a 4mm gap between butt ends.
- These joins must be supported underneath by the DuoSpan 136mm Beam except if used around the outside edge.

16



- The DuoSpan 99mm Joists can be attached to an outer frame using the DuoSpan 99 90° Angle Brackets for 90° joints, or the DuoSpan 99 Flexible Brackets.

17



- If the design incorporates a curve the Plas-Pro Fascia Support can be used to create the curve, the DuoSpan Joists can be fixed into this using the DuoSpan 99 Flexible Brackets.
- Noggins may be needed at the furthest point of this curve to hold it in place.
- To aid the installation of curves, pieces of Plas-Pro can be fixed into the cavity of the DuoSpan Joists for the Plas-Pro Fascia Support to be fixed to. The DuoSpan 99 Flexible Brackets must also be used in conjunction with this.

18

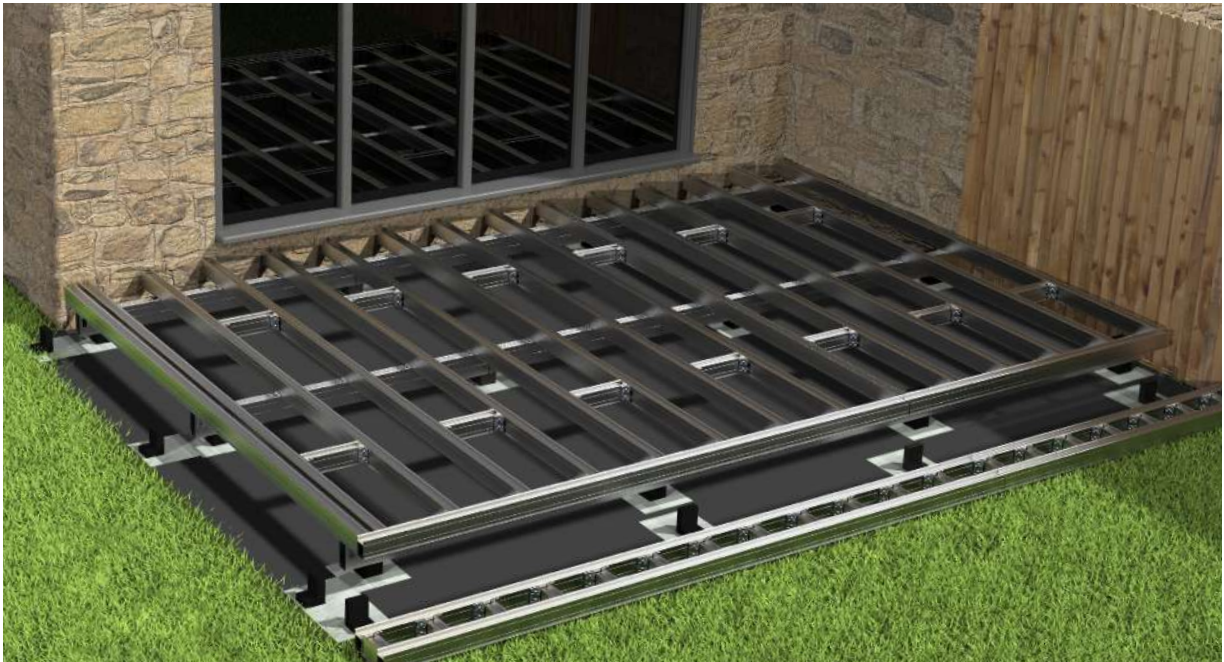

- The steps are built by constructing an outer frame first of DuoSpan Joists and inserting Joists along at the appropriate intervals.
- These frames are then attached to the Plas-Pro Posts in the ground and attached back to the DuoSpan Beams using DuoSpan 99 90° Angle Brackets.

19

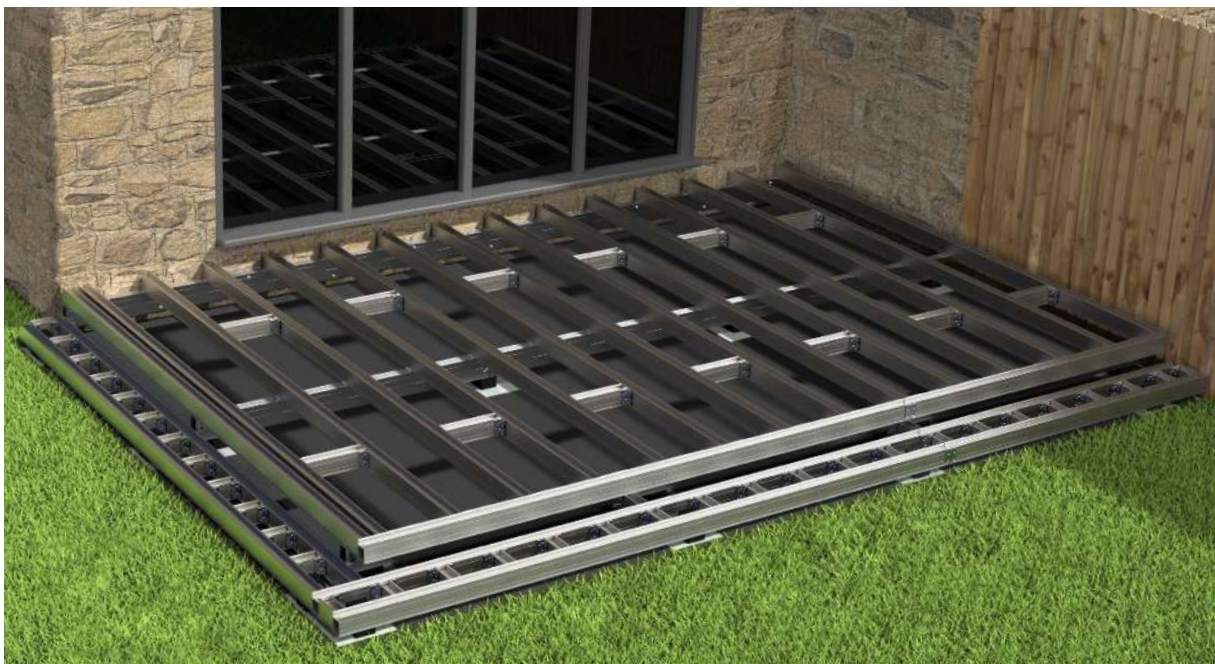

- If the front of the deck is more than 1 step high and requires more than 1 fascia board, the framework should be adequate to support this.

20

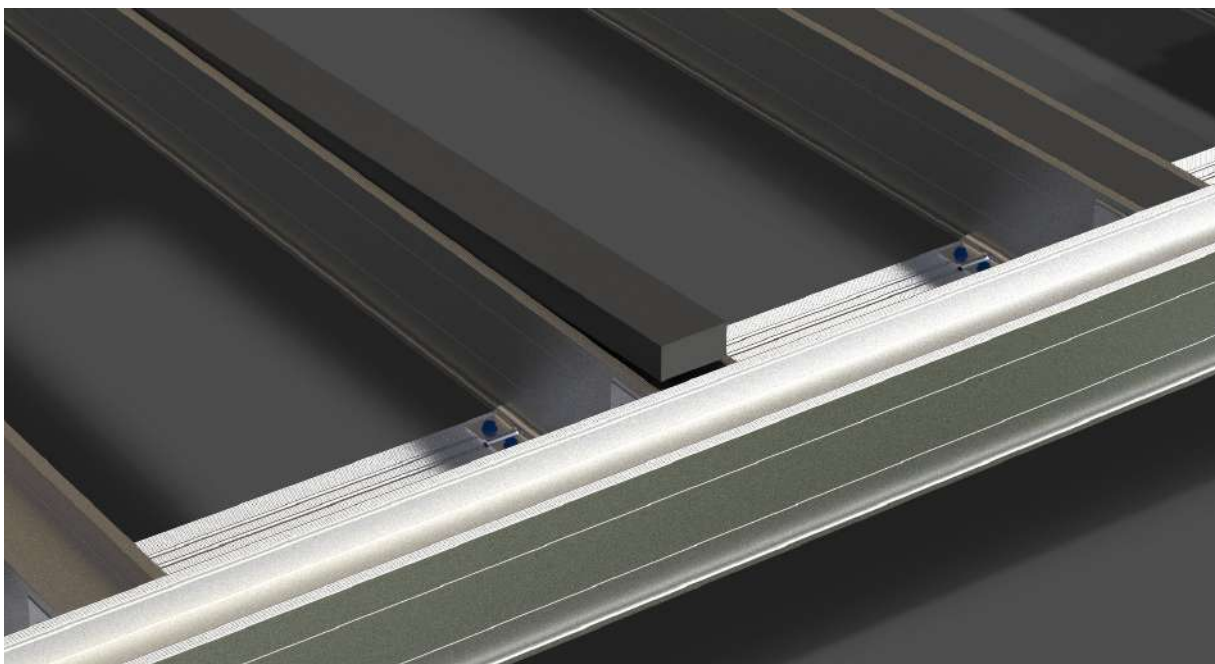

- Once all of the DuoSpan Joists are laid out, the DuoSpan Joist Insert can be laid inside the channel.
- The channels may need to be cleared to prevent any dirt lifting the insert.
- The DuoSpan Joist Insert is tapered, it is important that these Joist Inserts are put into the Joist with the tapered part at the bottom.
- If the project is exposed to high wind loads we recommend screwing the Joists Inserts in to the Joists at the end using the Plas-Pro to DuoSpan Screws.

21

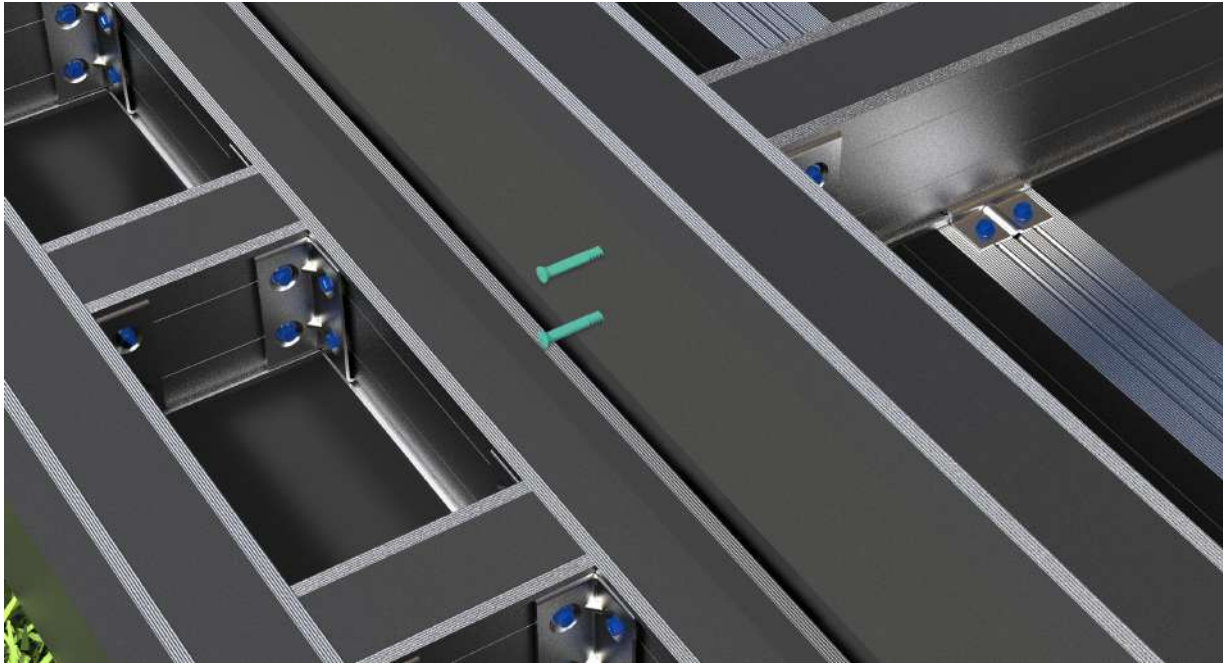

- Plas-Pro Fascia Support should be fixed to the outer Joist to fix the fascia and edging profiles to a 6.5mm hole should be pre-drilled through the Fascia Support with a HSS bit.
- The Plas-Pro to DuoSpan Screws should be used to fix to the Joists, with two fixings every 600mm along the Plas-Pro.

22



- When two lengths of DuoSpan Joist Insert or Plas-Pro Fascia Support come together a 10mm expansion gap must be left at butt ends.



- Now you have installed the subframe you can begin to install the boards.
- When fixing Millboard to the DuoSpan framework Durafix 4.5x45mm fixings must be used to fix the boards down. Durafix 4.5x35mm fixings must be used to fix the fascia to the Plas-Pro Fascia Support.
- As the DuoSpan profiles are made from aluminium this may be visible in the gaps between the boards, over time these will become less visible. 100mm DPC can be applied to the top of the Joists so the Joists can't be seen in the gaps between the boards.

Other Considerations:

- Where lighting is needed on the deck, any access holes in the Joist need to be done where the Joist is over the top of the Beam, access holes in the Beam need to be where the Beam is supported by the Plas-Pro Post.
- Where the framework will be touching or near to electricity cables, the framework will need to be earthed suitably.

DuoLift

DuoLift unpacked

Contents	Box Quantity	Heights	Material	Box code
A DuoLift Joist Cradle	10	15 - 60mm	Glass filled nylon	PMCP010
B DuoLift Self-Levelling Joint	10	20mm	Glass filled nylon	PMLP010
C DuoLift Riser	10	45mm	Glass filled nylon	PMRP010
D DuoLift Foot	10	45mm	Glass filled nylon	PMFP010
E DuoLift Acoustic Separation Pad	10	3mm	Agglomerated cork & rubber	PMAP010



A



B



C



D



E

DuoSpan

DuoSpan profiles

Contents	Dimensions	Material	Code
F DuoSpan 51mm Joist	51 x 68 x 3600mm	Aluminium	K5168J360
G DuoSpan 99mm Joist	99 x 68 x 3600mm	Aluminium	K9968J360
H DuoSpan 136mm Beam	136 x 63 x 3600mm	Aluminium	K1363B360



F



G



H

DuoSpan insert

Contents	Dimensions	Material	Code
I DuoSpan Joist Insert	25 x 54 x 2400mm	Recycled plastic	K2554B240



I

Plas-Pro

Contents	Dimensions	Material	Code
J Plas-Pro Fascia Support	100 x 25 x 3000mm	Recycled plastic	P0210B300
K Plas-Pro Post	100 x 100 x 3000mm	Recycled plastic	P1010B300



J



K

Accessories and fixings

Joist bracket sets for DuoSpan 51mm Joist

Contents	Quantity	Dimensions	Material	Box code
DuoSpan 51 90° Angle Bracket	10	–	Aluminium	K51RP010
DuoSpan Hex-head Screw	42	5.5 x 25mm	Cathodic barrier coated s/s	
DuoSpan 51 Flexible Bracket	10	–	Aluminium	K51FP010
DuoSpan Hex-head Screw	42	5.5 x 25mm	Cathodic barrier coated s/s	
DuoSpan Pan-head Screw	20	5 x 25mm	Cathodic barrier coated s/s	
DuoSpan 51 Straight Connector	10	–	Aluminium	K51LP010
DuoSpan Hex-head Screw	42	5.5 x 25mm	Cathodic barrier coated s/s	

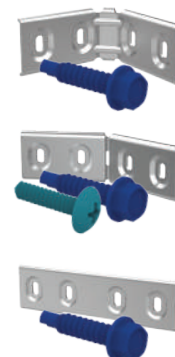

Joist bracket sets for DuoSpan 99mm Joist

Contents	Quantity	Dimensions	Material	Box code
DuoSpan 99 90° Angle Bracket	10	–	Aluminium	K99RP010
DuoSpan Hex-head Screw	42	5.5 x 25mm	Cathodic barrier coated s/s	
DuoSpan 99 Flexible Bracket	10	–	Aluminium	K99FP010
DuoSpan Hex-head Screw	42	5.5 x 25mm	Cathodic barrier coated s/s	
DuoSpan Pan-head Screw	20	5 x 25mm	Cathodic barrier coated s/s	
DuoSpan 99 Straight Connector	10	–	Aluminium	K99LP010
DuoSpan Hex-head Screw	42	5.5 x 25mm	Cathodic barrier coated s/s	

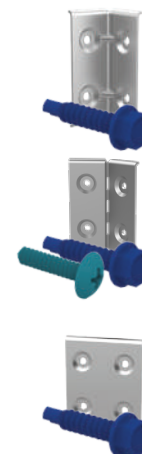

Hold-down clip

Contents	Quantity	Dimensions	Material	Box code
DuoSpan Hold-down Clip	30	–	Aluminium	K48CP030
DuoSpan Hex-head Screw	63	5.5 x 25mm	Cathodic barrier coated s/s	



Plas-Pro profile fixings

Contents	Quantity	Dimensions	Material	Box code
DuoSpan Bracket to Plas-Pro Screw	100	5 x 25mm	Cathodic barrier coated s/s	FD25P100
Plas-Pro to DuoSpan Screw	100	5 x 50mm	Cathodic barrier coated s/s	FD50P100

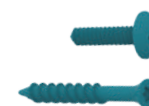

millboard.co.uk

© 2020 The Millboard Company Ltd., Millboard®, Lastane®, Durafix®, Lasta-Grip®, DuoSpan®, DuoLift® and the phrase "Live. Life. Outside.™" are protected trademarks. Patents and Patents Pending apply to Millboard® products. The company will vigorously defend its patent rights. Due to printing restraints, actual colours may vary from those shown in brochure. This brochure is not to be reproduced or copied without written permission from Millboard directors. Millboard has a policy of continual improvement to specification. Product blend, colours and sizes may change without notice. All sizes and measurements are nominal. Information is correct at time of going to press. Patent numbers include GB 2445714, GB 2449184, USA 8,065,849, CAN 2664329, EU 1951971.

The Millboard Company Ltd
UK Head Office
Unit A, Castle Court
Bodmin Road
Coventry CV2 5DB

T +44 (0) 24 7643 9943
F +44 (0) 24 7661 1668
E enquiries@millboard.co.uk

Company registered No. 06061318
VAT No: 980 616602

